



***MULTI-LAB* LABORATORY CASEWORK**

KEUR INDUSTRIES, INC.
18784 – 174TH Avenue
Spring Lake, Michigan 49456

Ph: 616-846-6990
Fax: 616-846-6996
www.keurindustries.com

CONTENTS

CABINET CONSTRUCTION	3
BASE CABINET	4 - 12
APRONS & UTILITY TABLES	13
SUPPLEMENTAL PARTS & ACCESSORIES	14 - 15
SPECIALITY EQUIPMENT	16
WALL & FLOOR CABINETS	17 - 18
SPECIAL PURPOSE STORAGE CABINETS	19- 20
COUNTER TOPS, SINKS & FIXTURES	21 - 22
LABORATORY DESIGN INFORMATION	23

DESIGNING TOMORROW'S LABORATORIES...

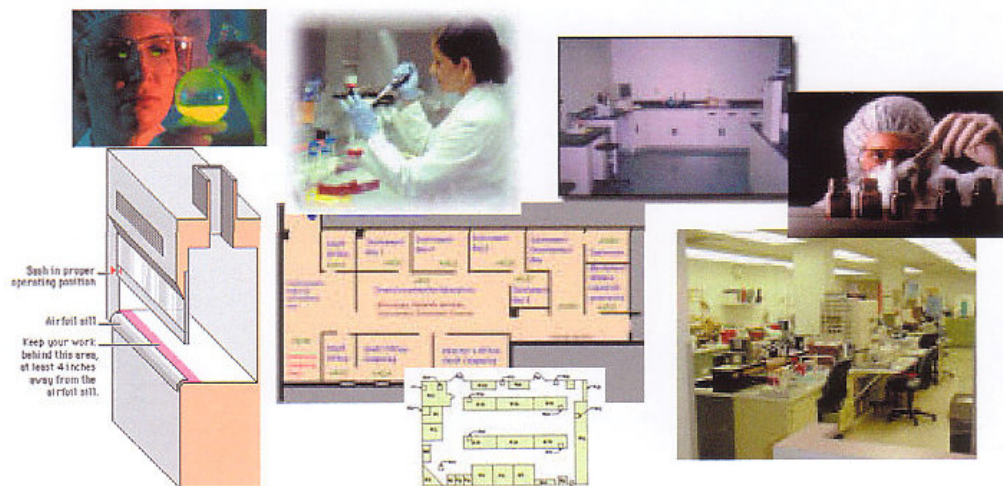

TODAY

PART NUMBERS, ILLUSTRATIONS, DESCRIPTIONS, SPECIFICATIONS AND MOST INFORMATION CONTAINED IN THIS CATALOG ARE BASED ON THE MOST CURRENT INFORMATION AVAILABLE AT TIME OF PUBLICATION. KEUR INDUSTRIES, INC. RESERVES THE RIGHT TO MAKE CHANGES AT ANY TIME WITHOUT NOTICE.

BASE CABINET CONSTRUCTION

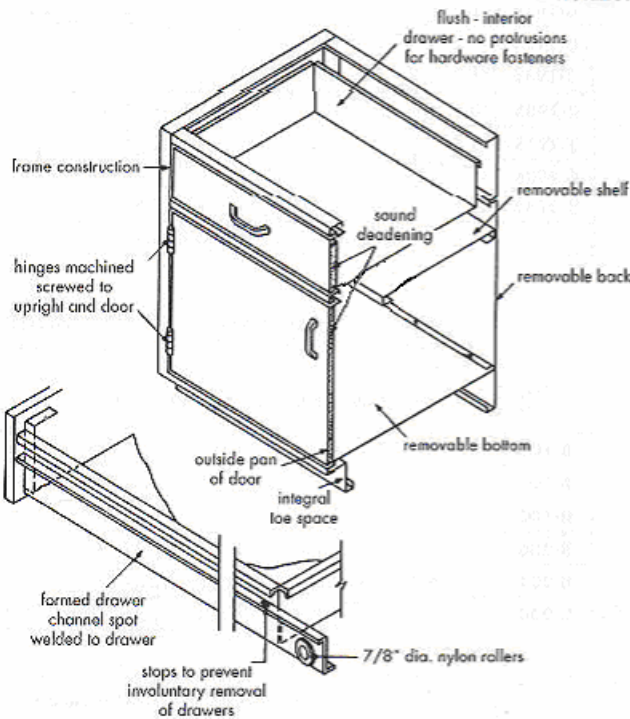
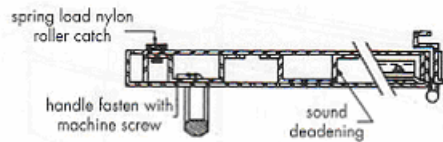
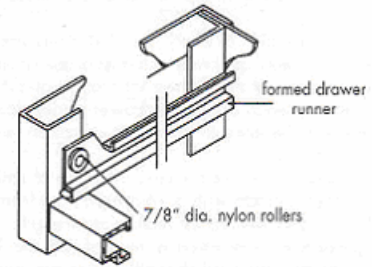
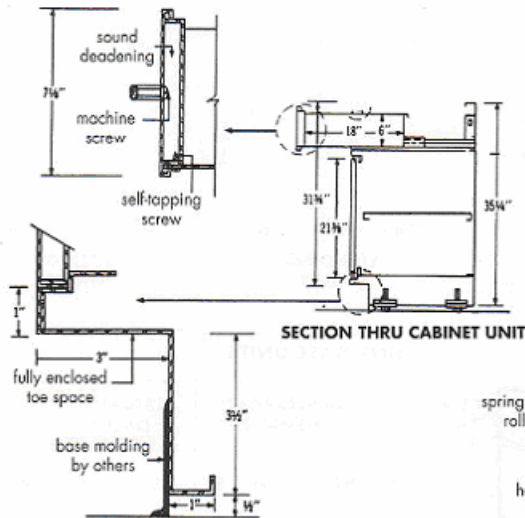

WORMS EYEVIEW LEVELING DEVICE

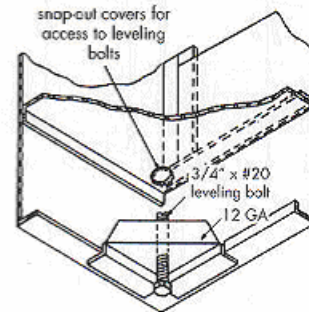

BASE CABINET SPECIFICATIONS

1. FRONT FRAME CONSTRUCTION – 16 GA.	7. DRAWER CHANNELS – 14 GA.
2. CROSS RAIL – 16 GA.	8. DRAWER ROLLER/NYLON STAINLESS STEEL, BALL BEARING
3. INTEGRAL FRONT TOE SPACE – 16 GA.	9. INNER DOOR LINER – 18 GA.
4. REMOVABLE BOTTOM – 20 GA.	10. OUTER DOOR PAN – 20 GA.
5. CORNER GUSSET – 11 GA.	11. SIDE PANELS, BACKS AND BOTTOMS – 20 GA.
6. DRAWER ASSEMBLY – 20 GA.	12. SIDE FRAMES PRE-PUNCHED FOR INTERCHANGEABILITY

BASE CABINET UNITS

The wide range of base units listed below and the following pages will meet every normal laboratory requirement. The add feature of being able to convert deep drawers to shallow drawers and vice-versa, provides extra flexibility for the user. Superior features that are part of every Keur Industries standard base cabinet:

1. All sectional units are constructed of prime grade steel.
2. The finishes are of the highest laboratory quality. The inner and outer faces of each door and drawer panel along with the cabinet are painted with the latest in baked on corrosion resistant powder coat paint technology.
3. Bottoms are removable for easy cleaning of spills beneath cabinets.
4. The cabinet is made with a 16-gauge front frame assembly, interlocked and welded for maximum strength.
5. One-piece toe construction is integral with the 16-gauge steel bottom front rail for easy cleaning, structural strength and to prevent hidden areas of chemical attack.

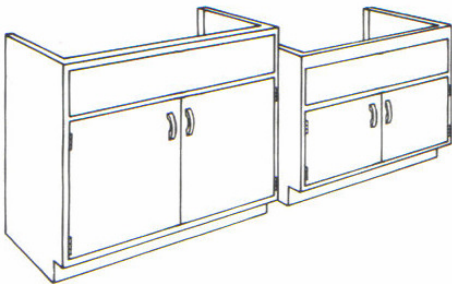
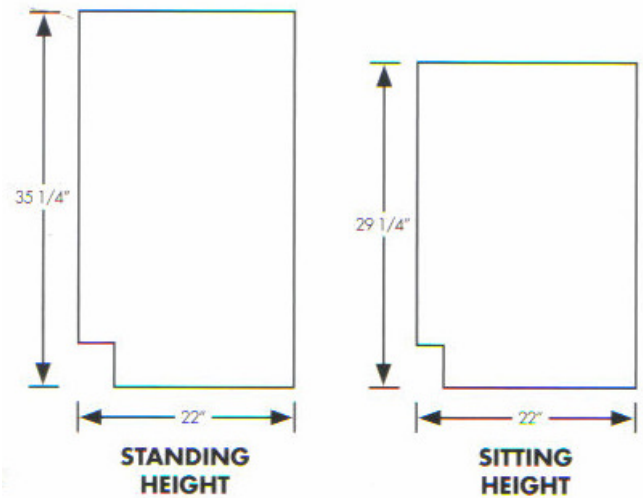

SINK BASE UNITS

Catalog Number	OVERALL DIMENSIONS			INSIDE DIMENSION DRAWER				INSIDE DIMENSION CUPBOARD		
	L	H	W	No.	L	H	W	L	H	W
B-198S	30	35-1/4	22					29-7/8	29	21
B-191S	35							34-7/8		
B-190S	47							46-7/8		
B-194S	58							57-7/8		
B-298S	30	29-1/4	22					29-7/8	21-7/8	21
B-291S	35							34-7/8		
B-290S	47							46-7/8		
B-294S	58							57-7/8		

NOTE: Cabinets have low back. Add SS for sink supports.

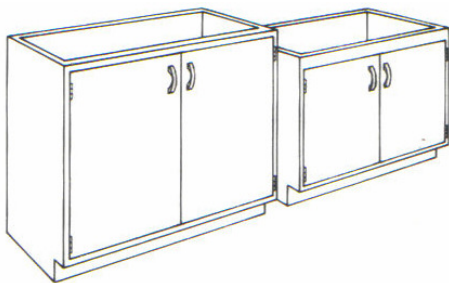

Catalog Number	OVERALL DIMENSIONS			INSIDE DIMENSION DRAWER				INSIDE DIMENSION CUPBOARD		
	L	H	W	No.	L	H	W	L	H	W
B-106	30	35-1/4	22					29-7/8	29	21
B-101	35							34-7/8		
B-100	47							46-7/8		
B-206	30	29-1/4	22					29-7/8	21-7/8	21
B-201	35							34-7/8		
B-200	47							46-7/8		

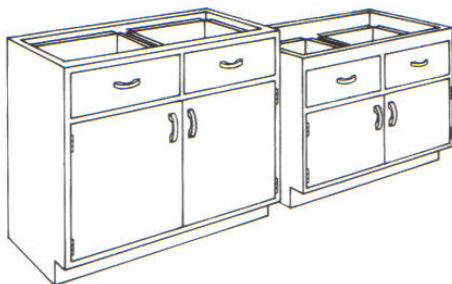

Catalog Number	OVERALL DIMENSIONS			INSIDE DIMENSION DRAWER				INSIDE DIMENSION CUPBOARD		
	L	H	W	No.	L	H	W	L	H	W
B-117	30	35-1/4	22	2	10 7/8	6	18	29-7/8	20 3/4	21
B-111	35				13 7/8					
B-110	47				19 7/8					
B-217	30	29-1/4	22	2	10 7/8	6	18	29-7/8	13 5/8	21
B-211	35				13 7/8					
B-210	47				19 7/8					

BASE CABINET UNITS



Catalog Number	OVERALL DIMENSIONS			INSIDE DIMENSION DRAWER			INSIDE DIMENSION CUPBOARD			
	L	H	W	No.	L	H	W	L	H	W
B-116	30	35-1/4	22	1	27 5/8	6	18	29-7/8	20 3/4	21
B-113	35				30 5/8			34-7/8		
B-112	47				42 5/8			46-7/8		
B-216	30	29-1/4	22	1	27 5/8	6	18	29-7/8	13 5/8	21
B-213	35				30 5/8			34-7/8		
B-212	47				42 5/8			46-7/8		

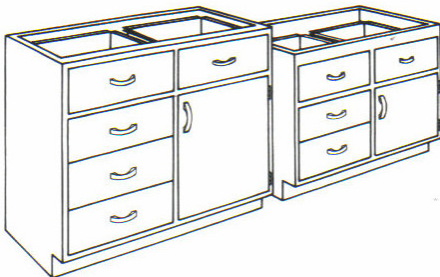

Catalog Number	OVERALL DIMENSIONS			INSIDE DIMENSION DRAWER			INSIDE DIMENSION CUPBOARD			
	L	H	W	No.	L	H	W	L	H	W
B-136	30	35-1/4	22	5	10 7/8	6	18	12-3/8	20 3/4	21
B-133	35				13 7/8			17-3/8		
B-132	47				19 7/8			23-3/8		
B-236	30	29-1/4	22	4	10 7/8	6	18	12-3/8	13 5/8	21
B-233	35				13 7/8			17-3/8		
B-232	47				19 7/8			23-3/8		

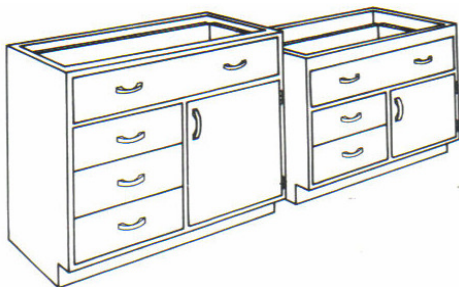

Catalog Number	OVERALL DIMENSIONS			INSIDE DIMENSION DRAWER			INSIDE DIMENSION CUPBOARD								
	L	H	W	No.	L	H	W	L	H	W					
B-139	30	35-1/4	22	1	25 5/8	6	18	12-3/8	20 3/4	21					
B-135	35			3	10 7/8			1			30 5/8	17-3/8			
				3	13 7/8			3			13 7/8	23-3/8			
B-134	47	1	42 5/8	3	19 7/8	1	27 5/8	12-3/8	13 5/8	21					
											2	10 7/8	1	30 5/8	17-3/8
B-239	30	29-1/4	22	6	18	1	27 5/8	12-3/8	13 5/8	21					
B-235	35										2	10 7/8	1	30 5/8	17-3/8
											2	13 7/8	1	42 5/8	23-3/8
B-234	47	1	42 5/8	2	19 7/8	1	27 5/8	12-3/8	13 5/8	21					
											2	10 7/8	1	30 5/8	17-3/8

BASE CABINET UNITS

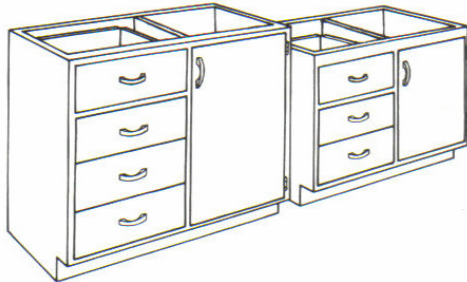

Catalog Number	OVERALL DIMENSIONS			INSIDE DIMENSION DRAWER			INSIDE DIMENSION CUPBOARD			
	L	H	W	No.	L	H	W	L	H	W
B-138	30	35-1/4	22	4	10 7/8	6	18	12-3/8	20 3/4	21
B-131	35				13 7/8			17-3/8		
B-130	47				19 7/8			23-3/8		
B-238	30	29-1/4	22	3	10 7/8	6	18	12-3/8	21 7/8	21
B-231	35				13 7/8			17-3/8		
B-230	47				19 7/8			23-3/8		



Catalog Number	OVERALL DIMENSIONS			INSIDE DIMENSION DRAWER			INSIDE DIMENSION CUPBOARD			
	L	H	W	No.	L	H	W	L	H	W
B-137	30	35-1/4	22	8	10 7/8	6	18			
B-129	35				13 7/8					
B-128	47				19 7/8					
B-237	30	29-1/4	22	6	10 7/8	6	18			
B-229	35				13 7/8					
B-228	47				19 7/8					



Catalog Number	OVERALL DIMENSIONS			INSIDE DIMENSION DRAWER			INSIDE DIMENSION CUPBOARD			
	L	H	W	No.	L	H	W	L	H	W
B-125	35	35-1/4	22	2	13 7/8	6	18			
				3	30 5/8					
B-124	47	35-1/4	22	2	19 7/8	6	18			
				3	42 5/8					
B-225	35	29-1/4	22	2	13 7/8	6	18			
				2	30 5/8					
B-224	47	29-1/4	22	2	19 7/8	6	18			
				2	42 5/8					

BASE CABINET UNITS



Catalog Number	OVERALL DIMENSIONS			INSIDE DIMENSION DRAWER			INSIDE DIMENSION CUPBOARD			
	L	H	W	No.	L	H	W	L	H	W
B-147	30	35-1/4	22	4	20 5/8	6	18			
B-127	35			30 5/8						
B-126	47			42 5/8						
B-247	30	29-1/4	22	4	20 5/8	6	18			
B-227	35			30 5/8						
B-226	47			42 5/8						



Catalog Number	OVERALL DIMENSIONS			INSIDE DIMENSION DRAWER			INSIDE DIMENSION CUPBOARD			
	L	H	W	No.	L	H	W	L	H	W
B-123	35	35-1/4	22	4	13 7/8	6	18			
B-122	47			2	30 5/8					
				4	19 7/8					
				2	42 5/8					
B-223	35	29-1/4	22	4	13 7/8	6	18			
B-222	47			1	30 5/8					
				4	19 7/8					
				1	42 5/8					

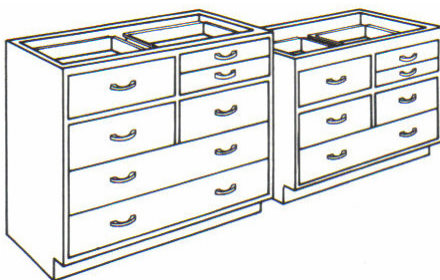

Catalog Number	OVERALL DIMENSIONS			INSIDE DIMENSION DRAWER			INSIDE DIMENSION CUPBOARD			
	L	H	W	No.	L	H	W	L	H	W
B-121	35	35-1/4	22	2	13 7/8	2 3/8	18			
B-120	47			3	13 7/8	6				
				2	30 5/8	6				
				2	19 7/8	2 3/8				
				3	19 7/8	5				
B-221	35			29-1/4	22	2		13 7/8	2 3/8	18
		3	13 7/8			6				
		1	30 5/8			6				
B-220	47	2	19 7/8			2 3/8				
		3	19 7/8			5				
		1	42 5/8			5				

BASE CABINET UNITS

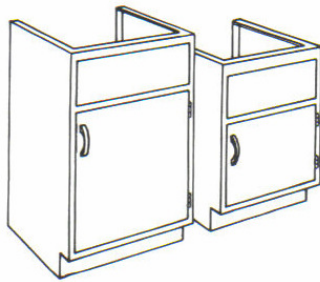

SINK BASE UNITS

Catalog Number	OVERALL DIMENSIONS			INSIDE DIMENSION DRAWER				INSIDE DIMENSION CUPBOARD		
	L	H	W	No.	L	H	W	L	H	W
B-193S	18 1/8	35-1/4	22					18	20 3/4	21
B-192S	24 1/8							24		
B-293S	18 1/8	29-1/4	22					18	13-5/8	21
B-292S	24 1/8							24		

NOTE: Cabinets have low back. Add SS for sink supports.

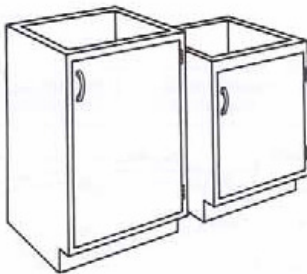

Catalog Number	OVERALL DIMENSIONS			INSIDE DIMENSION DRAWER				INSIDE DIMENSION CUPBOARD		
	L	H	W	No.	L	H	W	L	H	W
B-103	18 1/8	35-1/4	22					18	29	21
B-102	24 1/8							24		
B-203	18 1/8	29-1/4	22					18	21-7/8	21
B-202	24 1/8							24		

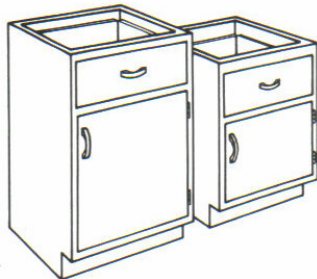

Catalog Number	OVERALL DIMENSIONS			INSIDE DIMENSION DRAWER				INSIDE DIMENSION CUPBOARD		
	L	H	W	No.	L	H	W	L	H	W
B-115	18 1/8	35-1/4	22	1	13 7/8	6	18	18	21 1/4	21
B-114	24 1/8				19 7/8			24		
B-215	18 1/8	29-1/4	22	1	13 7/8	6	18	18	18 1/8	21
B-214	24 1/8				19 7/8			24		

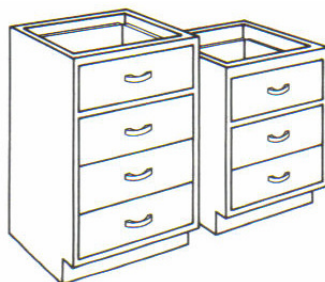

Catalog Number	OVERALL DIMENSIONS			INSIDE DIMENSION DRAWER				INSIDE DIMENSION CUPBOARD		
	L	H	W	No.	L	H	W	L	H	W
B-141	18 1/8	35-1/4	22	4	13 7/8	6	18			
B-140	24 1/8				19 7/8					
B-241	18 1/8	29-1/4	22	3	13 7/8	6	18			
B-240	24 1/8				19 7/8					

BASE CABINET UNITS



Catalog Number	OVERALL DIMENSIONS			INSIDE DIMENSION DRAWER			INSIDE DIMENSION CUPBOARD			
	L	H	W	No.	L	H	W	L	H	W
B-142	24 1/8	35-1/4	22	8	19 7/8	2 3/8	18			
B-242	24 1/8	29-1/4	22	6	19 7/8	2 3/8	18			

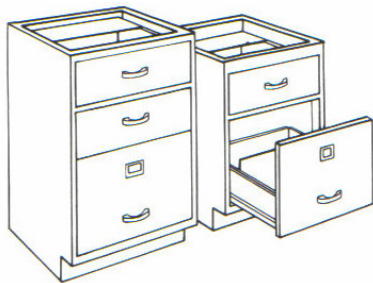

Catalog Number	OVERALL DIMENSIONS			INSIDE DIMENSION DRAWER			INSIDE DIMENSION CUPBOARD			
	L	H	W	No.	L	H	W	L	H	W
B-151	18 1/8	35-1/4	22	2	13 7/8	6	18			
				1	13 7/8	13 1/8				
B-150	24 1/8			2	19 7/8	6				
				1	19 7/8	13 1/8				
B-251	18 1/8	29-1/4	22	1	13 7/8	6	18			
				1	13 7/8	13 1/8				
B-250	24 1/8			1	19 7/8	6				
				1	19 7/8	13 1/8				

Note: Label holders on file drawer are optional

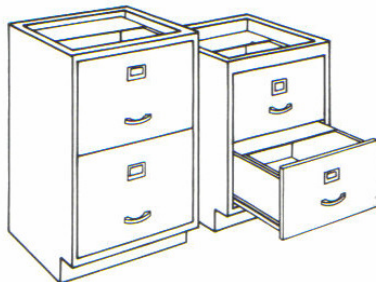

Catalog Number	OVERALL DIMENSIONS			INSIDE DIMENSION DRAWER			INSIDE DIMENSION CUPBOARD			
	L	H	W	No.	L	H	W	L	H	W
B-153	18 1/8	35-1/4	22	2	13 7/8	13 1/8	18			
B-152	24 1/8				19 7/8					
B-253	18 1/8	29-1/4	22	2	13 7/8	9 1/2	18			
B-252	24 1/8				19 7/8					

Note: Label holders on file drawer are optional

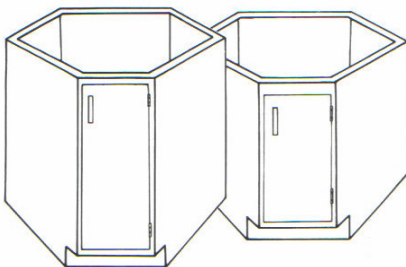

Catalog Number	OVERALL DIMENSIONS			INSIDE DIMENSION DRAWER			INSIDE DIMENSION CUPBOARD			
	L	H	W	No.	L	H	W	L	H	W
B-104	32	35-1/4	22							
B-204	32	29-1/4	22							

Notes:

- Unit is not furnished with shelf.
- Add suffix S for sink supports
- Add suffix LS for lazy susan.

BASE CABINET UNITS

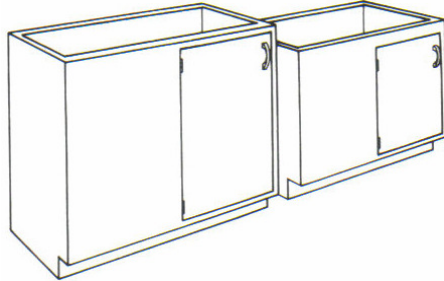

CORNER BASE UNITS

Catalog Number	OVERALL DIMENSIONS			INSIDE DIMENSION DRAWER				INSIDE DIMENSION CUPBOARD		
	L	H	W	No.	L	H	W	L	H	W
B-106BC	30	35-1/4	22					29-7/8	29	21
B-101BC	35							34-7/8		
B-100BC	47							46-7/8		
B-206BC	30	29-1/4	22					29-7/8	21-7/8	21
B-201BC	35							34-7/8		
B-200BC	47							46-7/8		

NOTE: Add suffix L or R to indicate location of door.

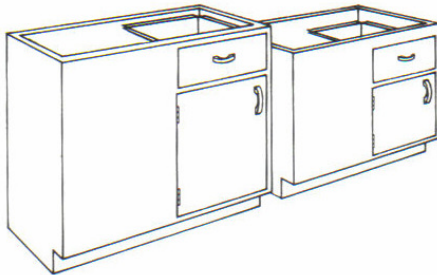

CORNER BASE UNITS

Catalog Number	OVERALL DIMENSIONS			No.	INSIDE DIMENSION DRAWER			INSIDE DIMENSION CUPBOARD		
	L	H	W		L	H	W	L	H	W
B-117BC	30	35-1/4	22	1	10 7/8	6	18	29-7/8	29	21
B-111BC	35				13 7/8			34-7/8		
B-110BC	47				19 7/8			46-7/8		
B-217BC	30	29-1/4	22	1	10 7/8	6	18	29-7/8	21-7/8	21
B-211BC	35				13 7/8			34-7/8		
B-210BC	47				19 7/8			46-7/8		

NOTE: Add suffix L or R to indicate location of door.

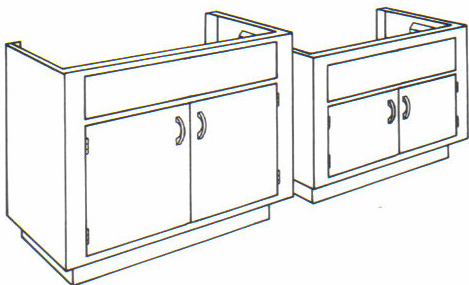

ISLAND SINK BASE UNIT

Catalog Number	OVERALL DIMENSIONS			No.	INSIDE DIMENSION DRAWER			INSIDE DIMENSION CUPBOARD		
	L	H	W		L	H	W	L	H	W
B-196S	52	35-1/4	22							
B-195S	58									
B-296S	52	29-1/4	22							
B-295S	58									

Note: Cabinets have low back. Add SS for sink supports

BASE CABINET UNITS

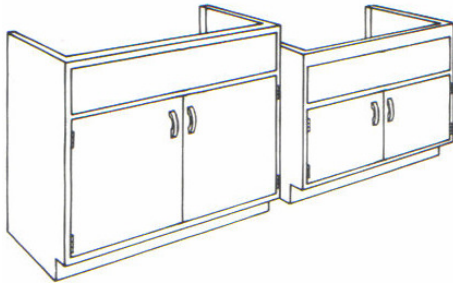

FUME HOOD BASE UNITS

Catalog Number	OVERALL DIMENSIONS			INSIDE DIMENSION DRAWER				INSIDE DIMENSION CUPBOARD		
	L	H	W	No.	L	H	W	L	H	W
B-198H	30	35-1/4	22					29-7/8	29	21
B-191H	35							34-7/8		
B-190H	47							46-7/8		
B-194H	58							57-7/8		
B-298H	30	29-1/4	22					29-7/8	21-7/8	21
B-291H	35							34-7/8		
B-290H	47							46-7/8		
B-294H	58							57-7/8		

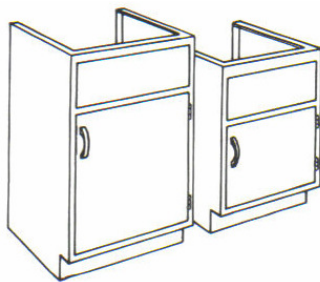

FUME HOOD BASE UNITS

Catalog Number	OVERALL DIMENSIONS			INSIDE DIMENSION DRAWER				INSIDE DIMENSION CUPBOARD		
	L	H	W	No.	L	H	W	L	H	W
B-193H	18 1/8	35-1/4	22					18	29	21
B-192H	24 1/8							24		
B-293H	18 1/8	29-1/4	22					18	21-7/8	21
B-292H	24 1/8							24		

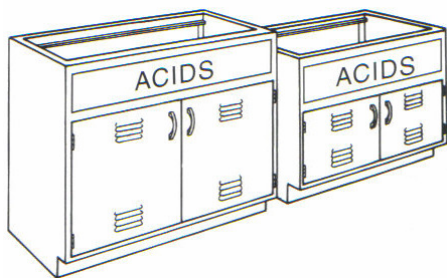

FUME HOOD ACID STORAGE BASE UNITS

Catalog Number	OVERALL DIMENSIONS			INSIDE DIMENSION DRAWER				INSIDE DIMENSION CUPBOARD		
	L	H	W	No.	L	H	W	L	H	W
B-198AS	30	35-1/4	22					29-7/8	21 1/4	21
B-191AS	35							34-7/8		
B-190AS	47							46-7/8		
B-194AS	58							57-7/8		
B-298AS	30	29-1/4	22					29-7/8	18-1/8	21
B-291AS	35							34-7/8		
B-290AS	47							46-7/8		
B-294AS	58							57-7/8		

Units to have a chemical resistant lining. Add Suffix "VK" for vent kit.

BASE CABINET UNITS

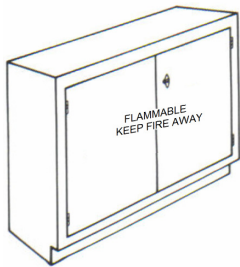

FLAMMABLE STORAGE BASE UNITS

Catalog Number	OVERALL DIMENSIONS			INSIDE DIMENSION DRAWER			INSIDE DIMENSION CUPBOARD			
	L	H	W	No.	L	H	W	L	H	W
B-106FS	30	35-1/4	22							
B-101FS	35									
B-100FS	47									
B-194FS	58									
B-206FS	30	29-1/4	22							
B-201FS	35									
B-200FS	47									
B-294FS	58									

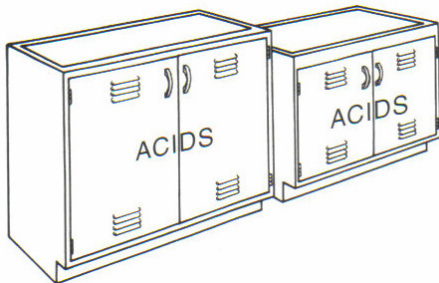

ACID STORAGE BASE UNITS

Catalog Number	OVERALL DIMENSIONS			INSIDE DIMENSION DRAWER			INSIDE DIMENSION CUPBOARD			
	L	H	W	No.	L	H	W	L	H	W
B-106AS	30	35-1/4	22							
B-101AS	35									
B-100AS	47									
B-206AS	30	29-1/4	22							
B-201AS	35									
B-200AS	47									

Units to have a chemical resistant lining.

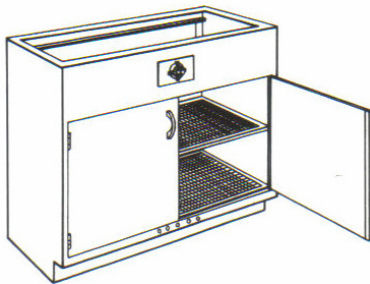

Electric Drying UNITS

Catalog Number	L	H	W	Wattage	No. of Elements	Voltage
B-198E	30	35-1/4	22	2000	4	220
B-191E	35			2500	5	
B-190E	47			3000	6	
B-194E	58			3500	7	

Drying Cabinets are fully insulated, self-venting and are furnished with perforated adjustable shelves. Local trades must wire units to that local codes are met.

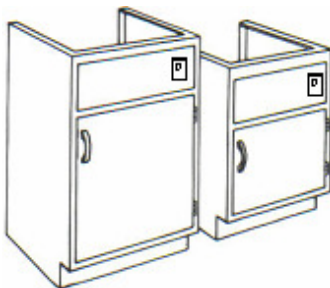

VACUUM PUMP STORAGE UNITS

Catalog Number	OVERALL DIMENSIONS			INSIDE DIMENSION DRAWER			INSIDE DIMENSION CUPBOARD			
	L	H	W	No.	L	H	W	L	H	W
B-193V	18 1/8	35-1/4	22					18	29	21
B-192V	24 1/8			24						
B-293V	18 1/8	29-1/4	22					18	21-7/8	21
B-292V	24 1/8			24						

Vacuum Pump Storage Cabinets is an insulated cabinet to provide enclosed space for vacuum pump storage. It features a switch plus one 115-volt electrical duplex receptacle to provide power to the vacuum pump. Local trades must wire units to meet local codes.

STANDARD APRON UNITS AND UTILITY TABLES

These apron units provide knee space under laboratory work areas so that the laboratory worker may work from the sitting position. The aprons provide exposed storage areas for large equipment or materials. The standard units are made to standard depth, heights and lengths of the base units so they can easily be integrated into the laboratory layout.



Type A unit

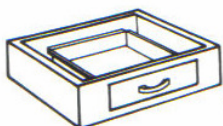

Type A-1
one drawer unit

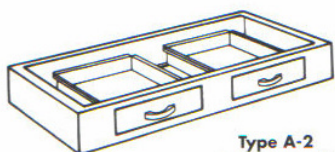

Type A-2
two drawer unit

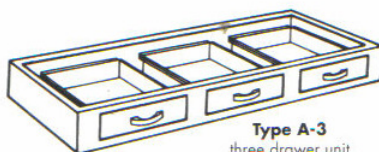

Type A-3
three drawer unit

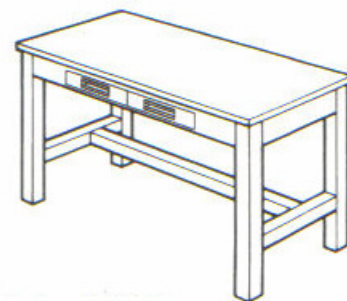
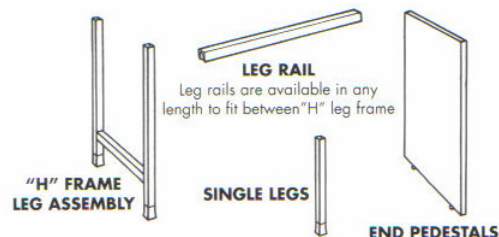
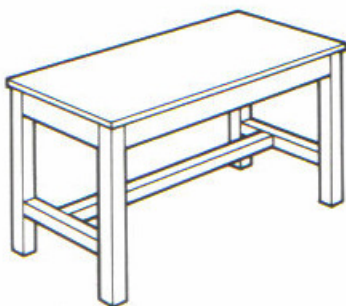

All aprons are 22" d x 4 5/8" h
NOTE: Add Suffix "-28" for 28" deep aprons

UNIT	CATALOG NUMBER	OVERALL APRON LENGTH	SIZE OF DRAWER(S)	UNIT	CATALOG NUMBER	OVERALL APRON LENGTH	SIZE OF DRAWER(S)
A	A-324	24 1/8		A-1	A-324-1	24 1/8	F
	A-330	30			A-330-1	30	F
	A-335	35			A-335-1	35	E
	A-342	42			A-342-1	42	E
	A-347	47			A-347-1	47	E
	A-352	52			A-352-1	52	E
	A-358	58			A-358-1	58	E
	A-370	70			A-370-1	70	E
A-2	A-342-2	42	F	A-3	A-358-3	58	F
	A-347-2	47	F		A-370-3	70	F
	A-352-2	52	F		All length sizes in inches, Drawer Sizes (I.D.), F= 13 5/8" w x 2 1/8" h x 19 1/8" d E= 19 5/8" w x 2 1/8" h x 19 1/8" d		
	A-358-2	58	E				
	A-370-2	70	E				

31" High Number	37" High Number	L	W	31" High Number	37" High Number	L	W
750-301	750-351	30	24	750-316	750-366	60	24
750-302	750-352	30	30	750-317	750-367	60	30
750-303	750-353	36	24	750-318	750-368	60	42
750-304	750-354	36	30	750-319	750-369	60	48
750-305	750-355	42	24	750-320	750-370	66	24
750-306	750-356	42	30	750-321	750-371	66	30
750-307	750-357	42	42	750-322	750-372	66	42
750-308	750-358	48	24	750-323	750-373	66	48
750-309	750-359	48	30	750-324	750-374	72	24
750-310	750-360	48	42	750-325	750-375	72	30
750-311	750-361	48	48	750-326	750-376	72	42
750-312	750-362	54	24	750-327	750-377	72	48
750-313	750-363	54	30				
750-314	750-364	54	42				
750-315	750-365	54	48				

31" High Number	37" High Number	L	W	No. of Drawers
750-328	750-378	30	24	1
750-329	750-379	30	30	1
750-330	750-380	36	24	1
750-331	750-381	36	30	1
750-332	750-382	42	24	1
750-333	750-383	42	30	1
750-334	750-384	48	24	2
750-335	750-385	48	30	2
750-336	750-386	54	24	2
750-337	750-387	54	30	2
750-338	750-388	60	24	2
750-339	750-389	60	30	2
750-340	750-390	66	24	3
750-341	750-391	66	30	3
750-342	750-392	72	24	3
750-343	750-393	72	30	3

The catalog number includes a 1" thick Phenolic Core counter top, other tops available when specified. The tables numbered 750-301 through 750-327 and 750-351 through 750-377 can be made of an all-welded 2" tube construction. To indicate all-welded construction, add "AW" at the end of number, i.e.: 750-301-AW. Vibration pads between work surface and frame can be provided when specified. To indicate a balance table, add "BT" to end of part number, i.e.: 750-301-BT.

SUPPLEMENTAL PARTS

Reagent Shelving

Reagent Shelving can be added to wall or center assemblies for additional storage space where supporting wall are not available. Reagent shelf supports and fascia panels are furnished in enameled steel...finished in any of our standard colors. All reagent shelf supports are available for wall table use also-they are furnished 8" wide and may be specified by adding "WT" to end of catalog number, example "RS-5-WT."

FASCIA PANEL (CAN BE PUNCHED FOR ELECTRICAL OR SERVICE FIXTURES)
*INDICATES LENGTH REQUIRED

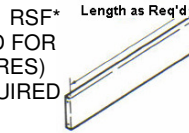

REAGENT SHELF SUPPORTS FOR USE WITH FACIA PANELS FOR SERVICES

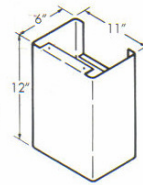

RS-1
Plumbing Box Upright

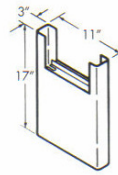

RS-2
Inside Upright

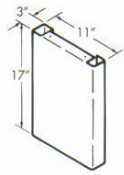

RS-3
End Upright

REAGENT SHELF SUPPORTS FOR SHELVING ONLY

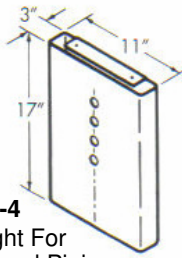

RS-4
Upright For Exposed Piping

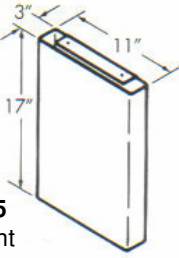

RS-5
Upright Plain

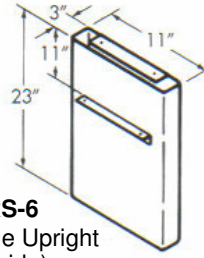

RS-6
Double Upright (Inside)

RS-7
Double Shelf Upright (Outside) Same as RS-6 Except Has (1) Intermediate Angle (Can be used Left or Right End)

FILLS PANELS & ENCLOSURES

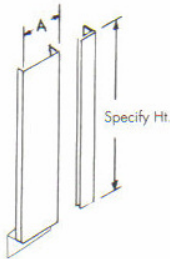

BASE FRONT FILL
TYPE BFF
BFF-3 A=3"
BFF-7 A=7"
BFF-14 A=14"

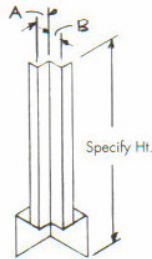

CORNER FILL
TYPE BCF
SPECIFY A & B DIMENSIONS

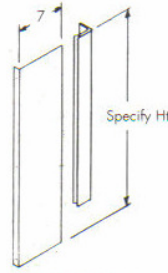

PIPE SPACE FILL
TYPE PSF-7



CENTER TABLE FILL
TYPE CTF
CTF-8 A=8"
CTF-14 A=14"

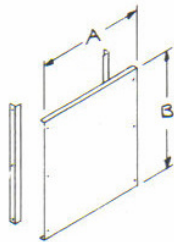

KNEE SPACE ENCLOSURE
TYPE KSE
SPECIFY A & B DIMENSIONS

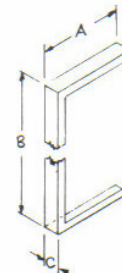

WALL CASE FILL
TYPE WCF
SPECIFY A, B & C DIMENSIONS

FOR BASE FILL PANELS, SPECIFY
H = STANDING HEIGHT (35 1/4")
L = SITTING HEIGHT (29 1/4")

CABINET ACCESSORIES



D-302 Sliding Door Lock



D-303 Cupboard Lock



D-304 Drawer Lock



D-305 Frameless Sliding Glass Door Lock

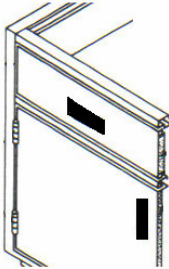

PVC Recessed

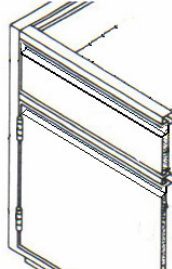

RH Recessed Pull (Built-in)



#603 Aluminum Pull (Standard)

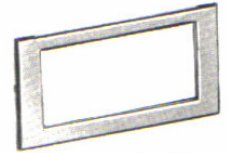

D-313 Card Holder



CC-35
Caster, swivel locking type
For use with cabinetry

CC-3F
Caster, same as above
Except fixed type



LC-38
Caster, swivel locking type for use with "H" legs



Pullout shelves are available in top rails of cabinets



Roll-out shelves are available

SPECIALTY EQUIPMENT

Y1-400 SERIES DISTILLATION RACK One Side Access Type

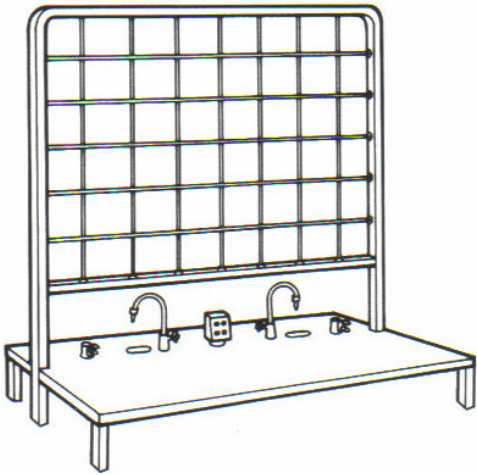

DISTILLATION RACK

The Y1-400 series distillation rack is designed for use along the wall and has open storage below the counter top. This item can be furnished with access from both side as listed blow. The work top is 18" high

Y1-400 SERIES DISTILLATION RACK ONE SIDE ACCESS TYPE

Catalog Number	Length	Depth	Height	Access From
Y1-401	6'0"	4'0"	8'0"	Both Sides
Y1-402	8'0"	4'0"	8'0"	Both Sides
Y1-403	10'0"	4'0"	8'0"	Both Sides
Y1-411	6'0"	2'6"	8'0"	One Side
Y1-412	8'0"	2'6"	8'0"	One Side
Y1-413	10'0"	2'6"	8'0"	One Side

Service Fixtures Shown: #927 cold water, #980-909 gas and #943A electric

TITRATION SUPERSTRUCTURE

The titration superstructure is designed to be mounted on existing units or sectional units or tables. Furnished with #944A electrical receptacle, glass panel, light switch and (4) 1/2" diameter aluminum rods. Light bulbs not included.

Catalog Number	Length	Depth	Height
Y1-801	36"	13"	36" or 48 1/4"
Y1-802	48"	13"	36" or 48 1/4"
Y1-803	60"	13"	36" or 48 1/4"

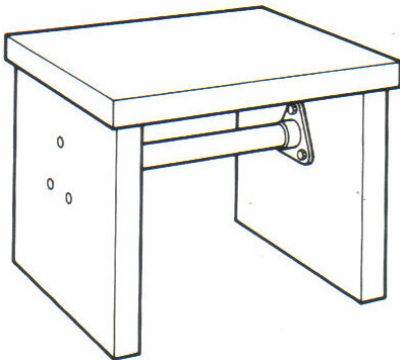
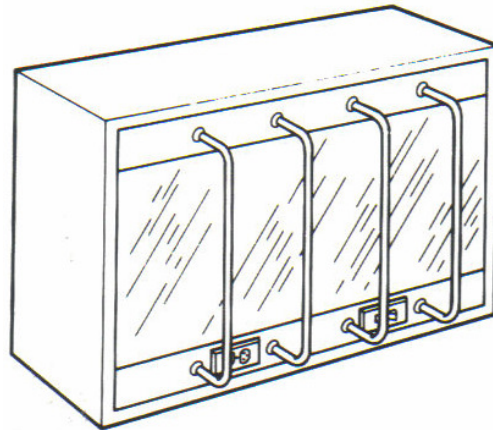

BALANCE TABLE

This balance table is made of epoxy resin. It is made to minimize and almost eliminate floor vibrations to assure the highest weighing accuracy. The table is furnished complete with epoxy side supports, top and tubular steel brace.

Catalog Number	Length	Depth	Height
Y10-20	35"	24"	30"

Y10-200 are shipped K.D. Shipping weight 625 lbs
Steel constructed balance tables are also available. See Page 3.

WALL STORAGE CABINETS

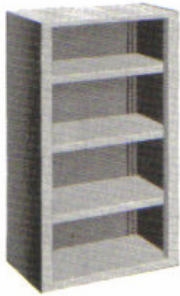

Open

Catalog Number	L	H	D
WO-122	18 1/8	30	13
WO-222	24 1/8	30	13
WO-3022	30	30	13
WO-322	35	30	13
WO-422	47	30	13
WO-132	18 1/8	36	13
WO-232	24 1/8	36	13
WO-332	35	36	13
WO-432	47	36	13
WO-342	35	48 1/4	13
WO-442	47	48 1/4	13
WO-346	35	48 1/4	16
WO-446	47	48 1/4	16
WOC-122	18 1/8	30	Corner
WOC-132	18 1/8	36	Corner
WOC-142	18 1/8	48 1/4	Corner

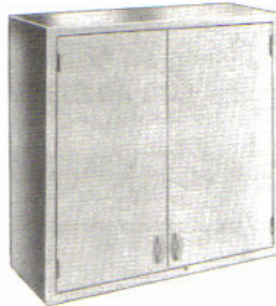

Solid Hinged Doors

Catalog Number	L	H	D
WD-122+	18 1/8	30	13
WD-222+	24 1/8	30	13
WD-3022	30	30	13
WD-322	35	30	13
WD-422	47	30	13
WD-132+	18 1/8	36	13
WD-232+	24 1/8	36	13
WD-332	35	36	13
WD-432	47	36	13
WD-342	35	48 1/4	13
WD-442	47	48 1/4	13
WD-346	35	48 1/4	16
WD-446	47	48 1/4	16
WDC-122	18 1/8	30	Corner
WDC-132	18 1/8	36	Corner
WDC-142	18 1/8	48 1/4	Corner

Number with + means single door



Glass Hinged Doors

Catalog Number	L	H	D
WB-122+	18 1/8	30	13
WB-222+	24 1/8	30	13
WB-3022	30	30	13
WB-322	35	30	13
WB-422	47	30	13
WB-132+	18 1/8	36	13
WB-232+	24 1/8	36	13
WB-332	35	36	13
WB-432	47	36	13
WB-342	35	48 1/4	13
WB-442	47	48 1/4	13
WB-346	35	48 1/4	16
WB-446	47	48 1/4	16
WBC-122	18 1/8	30	Corner
WBC-132	18 1/8	36	Corner
WBC-142	18 1/8	48 1/4	Corner

Number with + means single door



Solid Sliding

Catalog Number	L	H	D
WC-3022	30	30	13
WC-322	35	30	13
WC-422	47	30	13
WC-332	35	36	13
WC-432	47	36	13
WC-342	35	48 1/4	13
WC-442	47	48 1/4	13
WC-346	35	48 1/4	16
WC-446	47	48 1/4	16



Sliding Glass Doors

Catalog Number	L	H	D
WA-3022	30	30	13
WA-322	35	30	13
WA-422	47	30	13
WA-332	35	36	13
WA-432	47	36	13
WA-342	35	48 1/4	13
WA-442	47	48 1/4	13
WA-346	35	48 1/4	16
WA-446	47	48 1/4	16

Frameless Sliding Glass Doors

Catalog Number	L	H	D
WG-3022	30	30	13
WG-322	35	30	13
WG-422	47	30	13
WG-332	35	36	13
WG-432	47	36	13
WG-342	35	48 1/4	13
WG-442	47	48 1/4	13
WG-346	35	48 1/4	16
WG-446	47	48 1/4	16

FLOOR STORAGE CABINETS

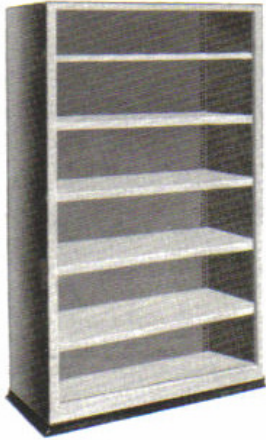

Open

Catalog Number	L	H	D
FO-176	18 1/8	84	16
FO-276	24 1/8	84	16
FO-376	35	84	16
FO-476	47	84	16
FO-172	18 1/8	84	22
FO-272	24 1/8	84	22
FO-372	35	84	22
FO-472	47	84	22

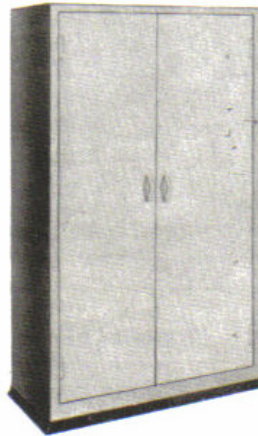

SOLID HINGED DOORS

Catalog Number	L	H	D
FD-176+	18 1/8	84	16
FD-276+	24 1/8	84	16
FD-376	35	84	16
FD-476	47	84	16
FD-172+	18 1/8	84	22
FD-272+	24 1/8	84	22
FD-372	35	84	22
FD-472	47	84	22



GLASS HINGED DOORS

Catalog Number	L	H	D
FB-176+	18 1/8	84	16
FB-276+	24 1/8	84	16
FB-376	35	84	16
FB-476	47	84	16
FB-172+	18 1/8	84	22
FB-272+	24 1/8	84	22
FB-372	35	84	22
FB-472	47	84	22

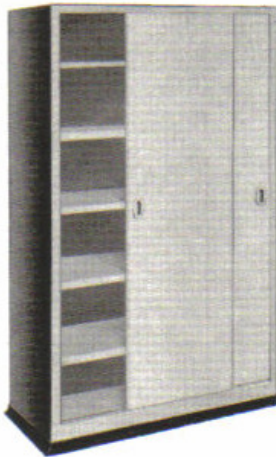

SOLID SLIDING DOOR

Catalog Number	L	H	D
FC-376	35	84	16
FC-476	47	84	16
FC-372	35	84	22
FC-472	47	84	22

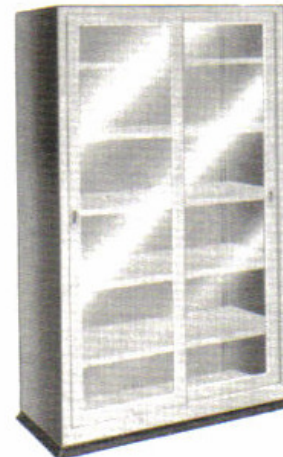

FRAMED GLASS SLIDING DOORS

Catalog Number	L	H	D
FA-376	35	84	16
FA-476	47	84	16
FA-372	35	84	22
FA-472	47	84	22

Notes: All floor storage cabinets to have 5 adjustable shelves.
 If sloping top is required, add the suffix "ST".
 Number with "+" means unit has a single door.



ELECTRIC DRYING CABINET

Electric drying cabinets are of double wall construction and fully insulated. Five expanded adjustable metal shelves are furnished in addition to expanded metal shelf over the electric strip heaters in the bottom of the cabinet. A thermostatic control, 0 – 250° F., 25 Amp, 220 volts AC for the strip heaters is included. DE-472 has a power consumption of 3000 watts, single phase 220 volts and DE-372 has a power consumption of 3500 watts, single phase, 220 volts.

Catalog Number	Length	Depth	Height
DE-372	35"	22"	84"
DE-472	47"	22"	84"

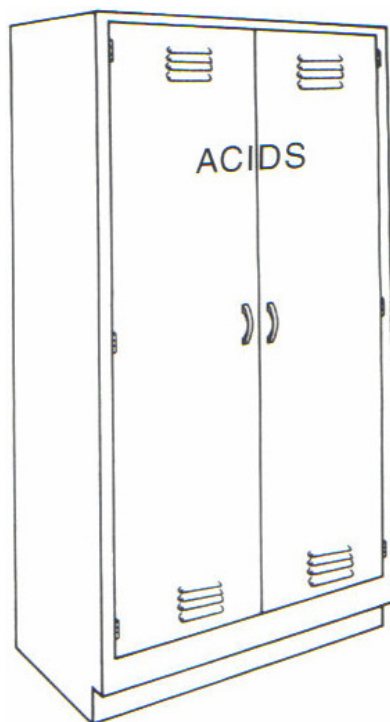

ACID STORAGE CABINETS

Acid storage cabinets provide a variety of storage space for reagents and solvents. They blend with other laboratory equipment and furniture in the laboratory. These cabinets have 5 adjustable shelves and will accommodate many different size containers.

Catalog Number	Length	Depth	Height
R8-121	35"	16"	84"
R8-122	47"	16"	84"

Special depth of 22" is available, when specified. Indicated with "22" suffix, i.e. "R8-123-22"

SPECIAL PURPOSE STORAGE



WARDROBE CABINET

Wardrobe storage cabinets are 22" deep and 84" high. These cabinets are provided with a horizontal bar for hanging clothes and a fixed shelf on one half of the cabinet. The other half comes with 5 adjustable shelves. (FD-242W has only hat shelf and clothes rod.)

Catalog Number	Length	Depth	Height
FD-272W+	24 1/8"	22"	84"
FD-372W	35"	22"	84"
FD-472W	47"	22"	84"
Number with "+" means unit has a single door.			



STANDARD STORAGE ASSEMBLIES

The R-6 series of storage cabinet assemblies combines the of wall cases with sectional unit storage and convenient work ledge. Upper section contains 3 adjustable shelves. Base cabinet contains 1 adjustable shelf. Locks can be furnished, when specified. Work ledge has a 1" overhang on 3 sides.

R-6 Type 1- Framed Sliding glass door above and steel hinged doors with 2 drawers below.

Catalog Number	Length	Depth	Height
R6-121	35"	23"	84"
R6-122	47"	23"	84"
Other cabinets types can be provide upon request.			

STYLES

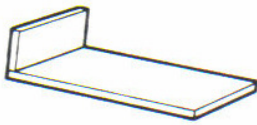

Type A

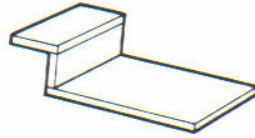

Type B

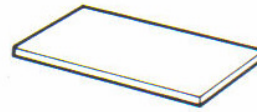

Type C

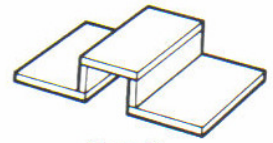

Type D

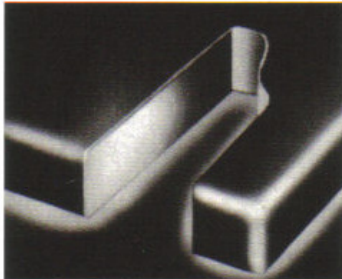

EPOXY RESIN

These tops are molded into a solid jet-black casting combining outstanding strength with chemical and thermal shock resistance. Several hours of high temperature curing develops maximum physical strength and chemical resistance.

Available in 3/4" and 1" thickness.

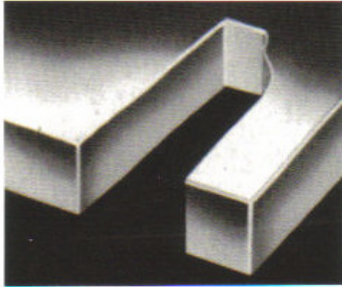

PHENOLIC CORE

This material is a high pressure laminate specifically designed for laboratory work tops. Phenolic core has the ability to outperform most work tops. Where chemical or stain resistance combined with superior physical characteristics is a priority, phenolic core should be considered.

Available in 3/4" and 1" thickness.

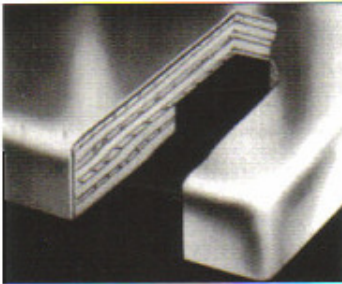

PLASTIC LAMINATE

This top is built up of a plastic sheet (Formica, Wilson Are, Micarta, etc.) in standard colors bonded with water-resistant adhesive to a 1 1/8" thick solid core particle board. All exposed edges are bonded with the same material as the top surface providing a top thickness of 1 1/4". Also available in a chemical resistant finish.

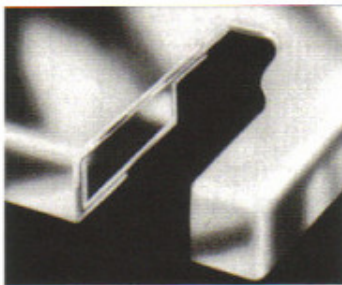

STAINLESS STEEL

These tops, curbs and shelves are fabricated of 16-gauge, Type 304 or 316 with a #4 finish. All corners, open ends and joints are continuous heliarc welded and ground smooth. Adequate box channel reinforcements are provided on the underside of the tops. An effective sound-deadening material is applied to the underside. Curbs and box can be an integral part of the top. Field joints, where required, can be supplied as either "butt joints" or "soldered joint," as required by specifications. Stainless steel sink bowls and cupsinks are integrally welded into the top, providing a joint-free assembly.

NOTE: Chemical resistant test data and maintenance information available upon request.

SINK AND SERVICE FIXTURES

** Additional Fixtures Are Available

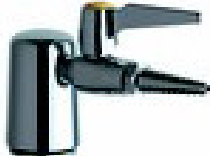

#981-909
Single Pedestal Cock
3/8" NPT Male Inlet Shank



#980-937
Single Pedestal Needle Valve
3/8" NPT Male Inlet Shank



#986-909
Single Flange Mounted
3/8" NPT Female Inlet Shank

#927
Manual Close
Single Service
Water Fixture



#929
Hot/Cold
Mixing Faucet



#969CTF
Self Closing
DI Water Fixture



#928
Manual Close
Single Service
Water Fixture

#930
Hot/Cold
Mixing Faucet
With Vacuum
Breaker

#969BPVC
Self Closing
PVC DI Water
Fixture

#944A
3-Wire polarized
flush receptacle,
1-gang outlet

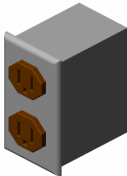

#940A
3-Wire polarized
single face,
1-gang outlet

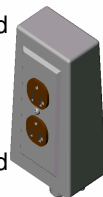

#942A
3-Wire polarized
single face,
1-gang outlet



#945A
3-Wire polarized
flush receptacle,
2-gang outlet

#945A
3-Wire polarized
double face,
2-gang outlet

#943A
3-Wire polarized
double face,
2-gang outlet

Standard Sink Sizes Cast Epoxy



CS-4R
3" x 6" cupsink
1 1/2" MNPS



Catalog Number	Length	Width	Depth	Drain Location
L-15C	16"	12"	8"	Center
L-25	18"	15"	8"	Corner
L-30	18"	15"	11"	Corner
L-33E	21"	17"	10"	End
L-50C	24"	16"	8"	Center
L-55	25"	15"	10"	Corner



SO-3R
Sink Tailpiece
1 1/2" MNPS

Other sizes available on request. Polypropylene & Stainless Steel available upon request.

Pegboards (epoxy, Phenolic Core, stainless steel), epoxy balance tables along with emergency eyewash and safety showers are also available.

When you are planning your next laboratory renovation, expansion or constructing a new laboratory, here are some helpful hints.

General Design Information

1. Wall benches can be either 24" deep (no pipe chase) or 30" deep (7" pipe chase).
2. Center tables can be either 46" wide (no pipe chase) or 54" or 60" deep with pipe chase.
3. Aisle space is important. The minimum recommended space is 48" to 72" between units.
4. A table height including the 1" worktop is 30" high (sitting) and 36" high (standing).
5. Service fixtures can be mounted in 7" pipe chase of 30" deep worktops or on the wall of 24" deep worktops. Also, service items such as sinks, fume hoods or safety equipment should be centrally located so space is properly utilized along with savings in cost.
6. Cabinets should be a good mixture of drawer and cupboard space for a well functioning laboratory.
7. Knee space area can be located throughout the laboratory.
8. Fume hoods should be located so they do not interfere with laboratory exits or room air service. For proper functioning of fume hoods, they should have a minimum number of angles and elbows.

A LABORATORY PLAN SHOULD ACCOUNT FOR WORK FLOW AND ADEQUATE SAFETY. HERE'S HOW TO PREPARE YOUR LABORATORY PLAN.

1. Measure the space to be used including all wall-to-wall, wall to door, etc. Show all irregularities including pipes, columns, etc. Draw this information on a piece of paper.
2. Select the size cabinets required to fill the spaces for the wall tables, center tables, etc. Sketch out the size units (18", 24", etc.). Remember to decide the depth of the worktop.
3. If you need additional overhead storage, choose the wall cabinet that best fits your needs and add it to your sketch.
4. Using this catalog, choose the cabinets that you need and be sure to include the catalog part number on the sketch.
5. Show the location of the sink(s) and service fixture(s) by placing an "X" where they are to be located. Note the cabinet; sink size and fixture(s) required.
6. Select and note on the sketch the work surface best suited for use in your laboratory.
7. List any other items you require for your laboratory that you would like for us to provide such as safety equipment, lab stools, etc.



Send the complete sketch to:

Keur Industries, Inc.

Attn: Estimating

18784 -174th Avenue

Spring Lake, MI 49456

Ph: 616-846-6990

Fax: 616-846-6996

Email: estimating@keurindustries.com

Be sure to include the following:

- Your project name, city, state and zip code.
- Your name, address, phone, fax and email.

Your sketch will be analyzed; a CAD drawing layout will be developed and returned with pricing.

Distributed by:



Keur Industries, Inc.
18784 – 174th Avenue
Spring Lake, MI 49456

Ph: 616-846-6990
Fax: 616-846-6996
www.keurindustries.com

Keur Industries, Inc. Products:

Multi-Lab Laboratory Casework, Heritage Fume Hoods, Discovery Bench Systems, Browne-Morse Laboratory Furniture

Copyright 2008 **Keur Industries, Inc.** Contents property of **Keur Industries, Inc.** May not be reproduced without permission. This document does not knowingly contain any untrue materials and products or omission to cause misleading information or guidelines.

KI-08-06

 Contract Holder